

T H E A L L - N E W



W R A N G L E R

Jeep

20
18

X

T H E D E F I N I T I V E G U I D E

Discovering new pathways to explore and persisting in the face of all obstacles has been the bedrock of our evolution.

OVERVIEW	8
LINEAGE	14
CAPABILITY	16
DRIVETRAIN	20
EFFICIENCY	26
OFF-ROAD FEATURES	28
OPEN-AIR DESIGN	30
TECHNOLOGY	42
RUBICON*	52
SAHARA*	58
COMFORT	70
SPORT	74
UTILITY	76
SAFETY & SECURITY	86
JEEP LIFE	92
MOPAR*	96

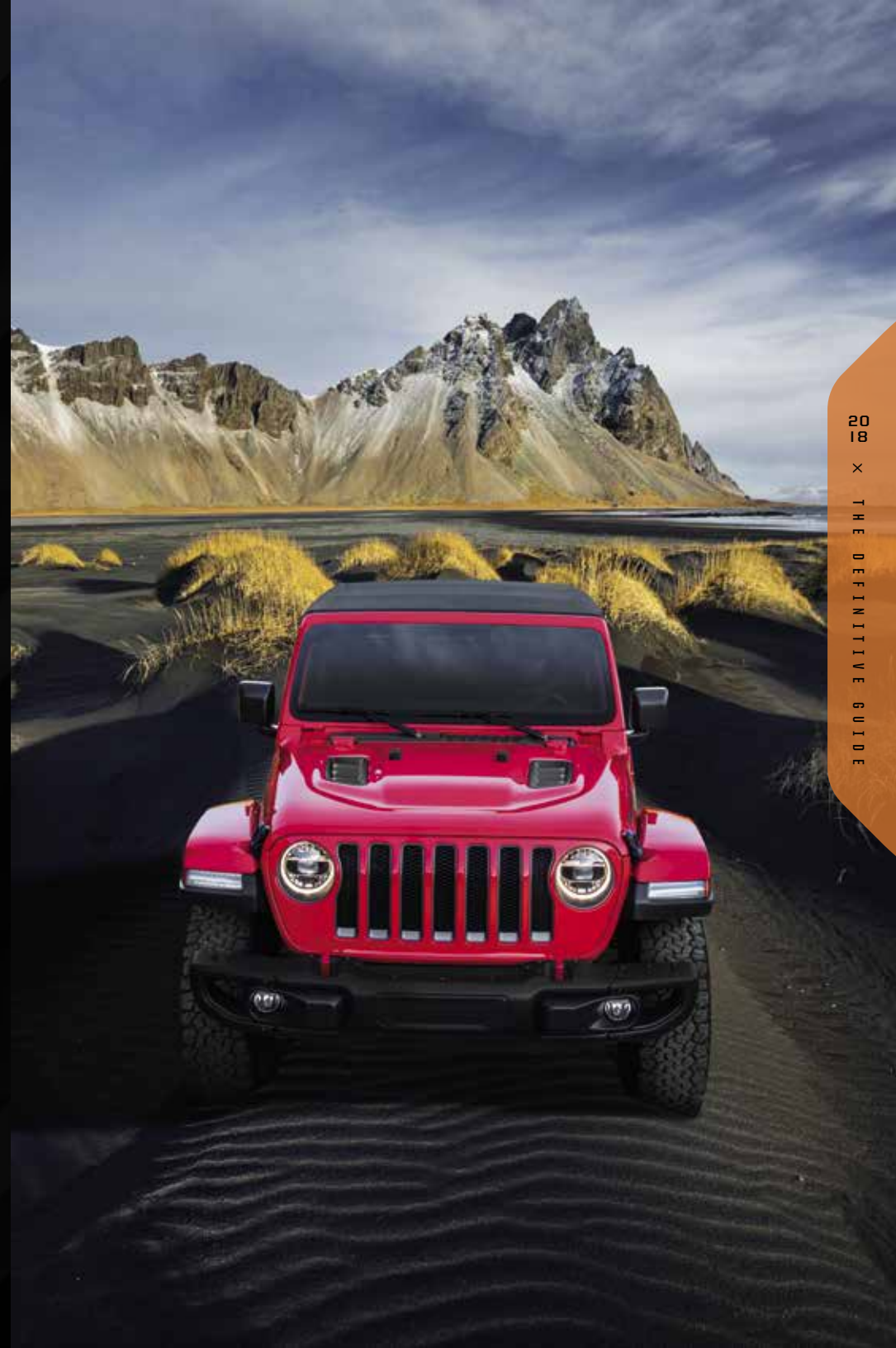

A BRAND-NEW PATH
TO THE TOP

IT'S AN EPIC EVOLUTION, WHERE DESIGN AND TECHNOLOGY TAKE A GIANT LEAP FORWARD. THIS ALL-NEW WRANGLER SURGES AHEAD, BRINGING WITH IT THE SPIRIT OF FREEDOM AND A PASSION FOR ADVENTURE. IT TAKES ON NEW LIFE WHILE RETAINING AN ICONIC PRESENCE RECOGNIZED AROUND THE GLOBE.

MOST CAPABLE
WRANGLER EVER

MOST ADVANCED
TECHNOLOGY OFFERED IN
A WRANGLER EVER

MOST FUEL-EFFICIENT
WRANGLER EVER



THREE WAYS TO TOP THE BEST Access to the open air, anywhere, is the uncontested right of every Wrangler owner. Three top style options make transitioning to fresh-air freedom easier than ever. Wrangler's standard Sunrider® Soft Top is now zipperless with spring-assisted folding, so opening up is faster than ever. The Freedom Top® modular hardtop has lighter, easier-to-remove front panels. And the brand-new Sky One-Touch™ Power Top lets you bask in the bright rays of the sun within seconds with the simple push of a button.

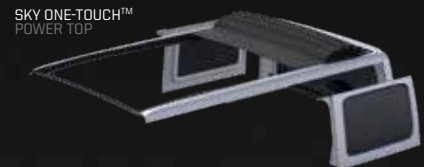

HOW DO YOU TOP
THE GREATEST
WRANGLER EVER?



WHEELS AND TIRES New and standard 33-inch All-Terrain off-road tires provide exceptional grip. Plus, Rubicon® wheel flares are designed to provide clearance for 35-inch tires with two additional inches of lift.

VENTED HOOD AND FENDER Rubicon is purpose-built for extreme exertion, which can affect temps in the engine compartment. Hood and fender vents work to prevent overheating, keeping the systems cool and functioning properly.

FOLD-DOWN WINDSHIELD AND REMOVABLE DOORS** Remove* just four windshield bolts to quickly fold down the windshield, securing it with provided straps. Side doors are made of lightweight aluminum and are now easier to remove* with included tool.

OFF-ROAD ARMOR Add guard detail to help prevent body damage. Off-road rock rails are standard on Rubicon® and constructed of heavy-gauge steel with Satin Black powder-coating, giving exceptional lower-body protection.

BODY-COLOR SPORT BAR WITH BUILT-IN SOUND BAR SPEAKERS Matched to the body-color of your Wrangler, the sport bar now blends in with the top on, and stands out with the top down. Built-in waterproof speakers deliver a Surround Sound experience.

FUEL-FILLER DOOR Made of aluminum and powder-coated Satin Black, the fuel door protects the fuel cap on Rubicon from debris and damage with an integrated body detail.

*A note about this brochure: all disclaimers can be found on the inside back cover.



TWO-DOOR/FOUR-DOOR The adventures will always be big, but how you ride through them is up to you. No matter which style you choose, the all-new Wrangler boasts improvements from every angle. The two-door Wrangler sports a classic profile and unmatched maneuverability, while the four-door Wrangler Unlimited has a formidable presence with expansive cargo capacity and room for five adults, including improved rear-seat leg room.



ICONIC GRILLE The face of the Jeep® Brand is recognized around the world. The iconic pairing of round headlamps and a seven-slot grille reflects more than 75 years of the Go Anywhere, Do Anything® spirit of freedom.

WINCH-READY BUMPER AND TOW HOOKS Now your Wrangler can arrive prepped for heavy use with a new, available winch-ready steel bumper, along with two always-standard front tow hooks.



LED LIGHTING When you want to illuminate more of the road ahead, available LED lamps do the trick. They're proven to throw more illumination down the road than less-powerful lighting systems. Go for the available LED Lighting Group to populate all exterior lights.



LIGHTWEIGHT SWING GATE WITH OPTIONAL TRAIL RAIL™ CARGO SYSTEM Constructed of high-strength magnesium and aluminum that reduces overall vehicle weight and aids efficiency and operation. Inside, the available Trail Rail™ Cargo System lets you easily accessorize and organize cargo.

PARKVIEW® REAR BACK-UP CAMERA² A camera mounted in the hub of the spare tire gives drivers a good look at the area behind the vehicle. The image appears on the Uconnect® touchscreen. A welcome new safety feature sure to save worry, dents and dings.

AVAILABLE STEEL REAR BUMPER Reinforced to withstand the punishment of the toughest trails out there. A rear tow hook is ever-present, so you can use your vehicle's strength to help those whose bravery exceeds their ability.



AMAZING VIEWS

Engineers and designers joined camps to revisit every inch of Wrangler's cabin. The exceptional quality of materials, the solid fit and finish, smartly placed controls, and a robust offering of upgraded conveniences hand over a premium driving experience that drivers and passengers immediately notice.

Rubicon® in Firecracker Red and Black leather-trimmed interior with Radical anodized mid-dash and Rubicon Red accent stitching

WILLYS MB 1941 - '45

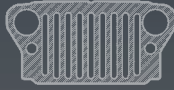

BEGINNINGS The first mass-produced Jeep® Brand vehicle is introduced in 1941. Its 4WD system is tested and proven around the world and has influenced every 4x4 manufactured ever since.

CJ-2A '45 - '49



A NEW CLASSIC The CJ-5 featured rounded body lines, softer seats and larger leaf springs. The CJ-7 arrived in 1976, with a longer wheelbase that made room for an automatic transmission, Quadra-Trac® 4WD and removable¹ hardtop and doors.

CJ-5 / CJ-7 '54 - '86



ALL IN A NAME Appearing for the first time in 1987 and forevermore, the name "Wrangler" fit perfectly with the vehicle's inherent spirit.

WRANGLER YJ '87 - '96



OUT OF THE BOX The much-anticipated 2003 Wrangler Rubicon® arrived fully equipped with locking differentials and mud tires, ready to conquer the trails.

WRANGLER TJ '97 - '06



WRANGLER GOES BIG The new JK "Unlimited" arrives in four-door form for the very first time beside the classic two-door style. Now five adventurers can head out, all under one roof.

WRANGLER JK '07 - '18



WRANGLER JL 2018



THE NEW FACE OF FREEDOM The all-new 2018 Wrangler adds a range of advanced technology, as well as an evolution of style.

THE FACE OF FREEDOM
FROM THE VERY START



WRANGLER X THE DEFINITIVE GUIDE TO CAPABILITY



CLASS V
CAPABILITY



TRAIL RATED®



1 SUPERIOR TRACTION



33-INCH ALL-TERRAIN TIRES
Aggressive tread design grabs on to the ground below and won't let go.

EXCLUSIVE ON RUBICON®
While the 33-inch All-Terrain tire is standard, the high-clearance front fenders on Rubicon can take on 35-inch tires with just an extra 2-inch lift.

SPECIAL CONSTRUCTION
Specially formulated, thick rubber construction provides protection and reduces chips and tears.

THE FIVE VIRTUES OF MASTERY



2 WATER FORDING*



3 MANEUVERABILITY



Rubicon® in Billet Silver Metallic

PROVEN TO EXCEL EVERY
WRANGLER IS DESIGNED AND BUILT TO EXCEL IN FIVE DISTINCT AREAS OF PERFORMANCE. THIS ENSURES THAT YOU CAN DEPEND ON IT TO MASTER THE TOUGHEST ROAD AND WEATHER CONDITIONS. IN YOUR TRAIL RATED® JEEP® WRANGLER, YOU'RE IN COMMAND OF EXCLUSIVE, AUTHENTIC FOUR-WHEEL-DRIVE CAPABILITY. CONFIDENTLY MOVE FORWARD TO SEE WHAT THE WORLD IS REALLY MADE OF.



4 GROUND CLEARANCE



5 ARTICULATION



JEEP® 4x4 SYSTEMS

COMMAND-TRAC® 4x4 SYSTEM

For off-road and all-weather capability, this part-time, shift-on-the-fly system divides torque 50/50 between front and rear axles for tough traction. The NV241 6II transfer case shifts smoothly from 2WD to 4WD at speeds up to 45 mph. For serious rock-crawling, its 2.72:1 low range ensures confidence. (Standard on Sport and Sahara.)*

ROCK-TRAC® 4x4 SYSTEM

Rubicon® rides with this extreme 4WD system. Its 4:1 low-gear ratio allows Wrangler Rubicon to crawl at a low speed for greater control and increases the amount of torque available at the wheels. (Standard on Rubicon.)



SELEC-TRAC® FULL-TIME 4x4 SYSTEM

This proven Jeep® Brand four-wheel-drive system, with its active 4WD transfer case, does all the thinking so you can concentrate on the scenery. Selec-Trac® analyzes the situation for you and sends torque to the wheels with the most grip. The system provides continuous, optimum traction that effortlessly conquers snow, ice, rocks, mud and everything in between. The system's Smart Lock maintains constant 4WD action when you take to the trail or face challenging road conditions. Available on Sahara.



3.6L PENTASTAR® V6 ENGINE

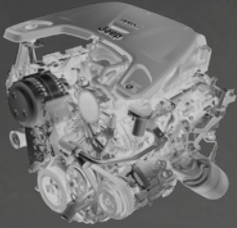

285
horsepower

260
lb-ft of torque

It has starred as THE engine for Jeep® Wrangler since 2012, with a much-celebrated award-winning performance history. Enhancements to this proven road star include weight reductions that boost the engine's performance, and friction-reducing applications that ensure its smooth operation. Fuel-economy improvements of nearly 11 percent compared to the previous Pentastar generation add even more value. The engine's increased efficiencies are helped by the addition of Engine Stop/Start (ESS) technology, while it remains a brawny performer, boasting 285 horsepower and 260 lb-ft of torque. Available with a 6-speed manual or 8-speed automatic transmission.

ENGINE STOP/START TECHNOLOGY (ESS) Say hello to this new feature on the 3.6L Pentastar engine. Its job is to help reduce CO₂ emissions and improve efficiency by using a dual-battery system and sophisticated controls to reduce fuel flow and turn off the engine when the vehicle brakes to a stop. When the brake or clutch pedal is released, the engine seamlessly restarts and the transmission engages.

2.0L TURBO I-4 ENGINE



270
horsepower

295
lb-ft of torque

This all-new engine performs with V6 muscle, yet sips fuel as an I-4 should. The 2.0L Turbo I-4 engine steps into a new world by offering fuel-saving/energy-generating functions that include auto-stop/start, electric power assist, extended fuel shutoff, transmission shift management, intelligent battery charging and regenerative braking. Direct injection boosts power while reducing emissions, and ESS technology improves fuel economy. It's a perfect match of superior strength teamed up with welcome modern efficiencies. With its standard match to the new 8-speed transmission, you'll enjoy strong takeoffs and smooth highway coasting.

ESS operates behind the scenes, virtually unnoticed, to help reduce fuel consumption by automatically shutting down the engine while stopped at traffic lights and highway snarls. It then restarts when the driver releases the brake or clutch pedal or presses on the accelerator pedal. Optimal powertrain efficiencies are realized by managing transmission shift schedules according to individual driving styles.

No worries about running down the battery power when the engine is off – an auxiliary electricity source operates accessories, such as heater and A/C blower fan, audio system, wipers and headlights.

TWO HEARTS, ONE SOUL

NOW YOU CAN CHOOSE HOW YOU WANT TO GET YOUR BLOOD PUMPING. THE ADDITION OF THE AVAILABLE 2.0L TURBO I-4 ENGINE HAS THE TORQUE AND POWER FOR FAST STARTS. THE RELIABLE 3.6L PENTASTAR® HAS THE BRAWN TO GET YOU AHEAD OF THE PACK, AND KEEP YOU THERE.





Sahara® Unlimited in Bright White



6-SPEED MANUAL TRANSMISSION New and improved, it has a 50 percent shorter shifter throw, lower 1st and Reverse gears for improved off-roading, and an added vent tube to help safely traverse higher water fording² levels. It comes standard, matched to either a Command-Trac[®] 4WD system on Sport and Sahara[®] or paired with the Rock-Trac[®] 4WD system on Rubicon[®].

PULLING POWER Wrangler Unlimited can confidently tow up to 3,500 lb when properly equipped with the available Trailer Tow and HD Electrical Group. Trailer Sway Control[™] helps keep you and the toys you tow safely on course. Wrangler is also ideal for towing behind an RV, so you can bring open-air off-road capability wherever you go.



Properly secure all cargo.

Sahara Unlimited in Granite Crystal Metallic

THE STRENGTH OF EIGHT



NEW 8-SPEED AUTOMATIC TRANSMISSION With smooth, quick efficiency, this transmission provides additional gears with no gain in weight, enhanced acceleration with reduced fuel consumption, and increased torque with added strength to pull.



GO WITH THE FLOW

WRANGLER x THE DEFINITIVE GUIDE / EFFICIENCY

THE MOST AERODYNAMIC WRANGLER EVER REDUCES DRAG WITH DESIGN EFFICIENCIES THAT LET AIR SLIP AROUND ITS BODY AS SMOOTHLY AS POSSIBLE. IT'S ALSO THE QUIETEST WRANGLER EVER, DELIVERING A PREMIUM DRIVING EXPERIENCE THAT FEELS PLEASINGLY UPSCALE, AND THAT'S OKAY WHEN YOU'RE ALSO EXCEPTIONALLY CAPABLE AND STRONG.

ALL'S QUIET
The use of acoustic windshield glass and additional sound deadening on the dashboard and floor insulation help deliver the quietest Wrangler ever.

AERO IMPROVEMENTS
The raked windshield and round curves help the vehicle slip through the air with reduced drag.

ADVANCED DRIVETRAINS
Every component at the core of Wrangler's drivetrain, from the all-new available 2.0L Turbo I-4 engine to the smooth-shifting 8-speed automatic transmission, has been designed to minimize weight and fuel consumption and maximize efficiency.

LIGHTER IN WEIGHT
High-strength, lightweight aluminum is used throughout the doors, hood, windshield frame, swing gate, and fenders to help Wrangler shed over 200 lb. It's strong, durable and aids efficiency.

CONFIDENCE
FROM THE
GROUND UP

MORE CAPABLE THAN EVER,
THE ALL-NEW WRANGLER
RUBICON® IS FULLY
ARMORED, ALLOWING
YOU TO OVERCOME
ALL OBSTACLES WITH
THE CONFIDENCE OF
A TRUE WARRIOR.

1. WINCH-CAPABLE STEEL FRONT BUMPER Engineered with ultra-strong steel and outfitted to accept a winch, this bumper is built to take the punishment of off-road trails. End caps are easily removable¹ to help maneuver you through tight spots.

ELECTRONIC FRONT SWAY BAR DISCONNECT SYSTEM Flip a switch and the sway bar can be disconnected in 4-Hi or 4-Lo. It automatically will reconnect at speeds above 18 mph and disconnect again under 18 mph, if selected. This allows the front suspension to travel up to 25 percent more on Rubicon® versus being connected.

IMPROVED CRAWL RATIOS Maximized to deliver even more brawny boulder-pounding strength, the crawl ratio for Rubicon with a manual transmission is raised to 84:1, and to 77:1 when outfitted with the automatic transmission.

2. TRU-LOK® LOCKING DIFFERENTIALS Front and rear electronic-locking differentials deliver maximum torque to both wheels, maintaining forward momentum for the ultimate in 4WD traction. An instrument panel-mounted rocker switch can lock either the rear or both axles. (Standard only on Rubicon.)

DANA® 44 HEAVY-DUTY SOLID AXLES Now twice as strong as those of the previous generation, with even more corrosion resistance. Supreme durability comes from heavy shafts, stiff housings, large pinion bearings and above-center pinion mountings for a smooth and quiet operation. (Front and rear standard on Rubicon. Rear standard on Sport and Sahara.)

HEAVY-DUTY SUSPENSION Solid axles with locating arms, track/stabilizer bars, coil springs, a front steering damper and tunable monotube shock absorbers are firm at low speeds and more relaxed at higher speeds. (Standard on Sahara.® A performance suspension is standard on Rubicon.®)

3. ROCK-TRAC® 4x4 SYSTEM Rubicon rides with this extreme 4WD system. Its 4:1 low-gear ratio allows Wrangler Rubicon to crawl at a low speed for greater control and increases the amount of torque available at the wheels. (Standard only on Rubicon.)

OFF-ROAD TIRES Grabby and rugged, 33-inch Off-Road All-Terrain tires are standard on Rubicon.

TOW HOOKS Two in the front and one in the rear are always standard, made from heavy-duty, forged-steel and mounted directly to the frame.

ROCK RAILS Heavy-gauge steel rock rails are mounted directly to the body for additional rocker panel protection. (Standard only on Rubicon.)

SKID PLATES Made from high-strength steel for weight savings and increased strength. Four skid plates/bars protect the underbody. The automatic transmission skid plate enables crossmember removal¹ for weight savings.

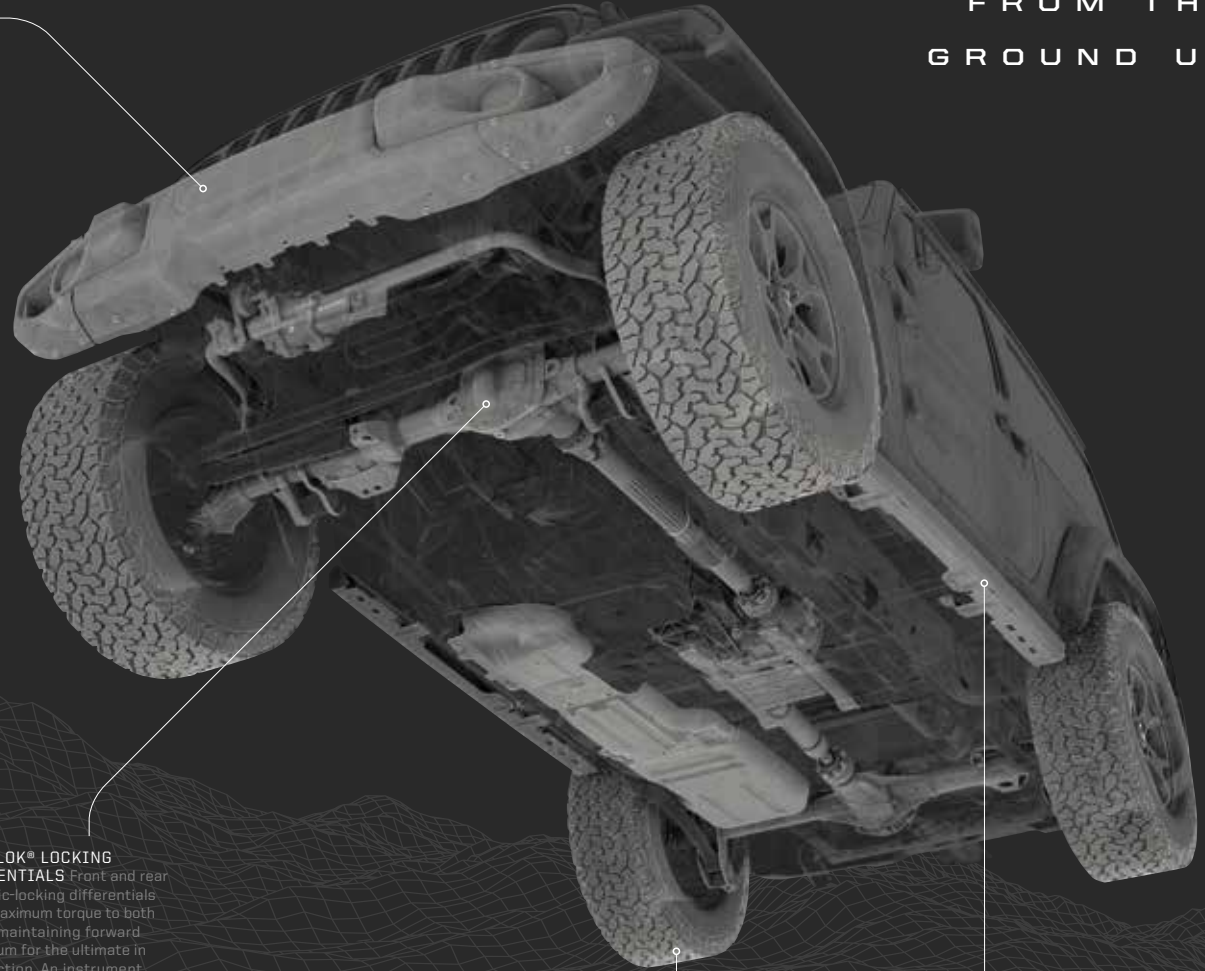

RUBICON STANDS IN A CLASS
BY ITSELF, READY FOR
THE MOST GRUELING
CHALLENGES UPON
ARRIVAL.



TAKE IT ALL IN

WRANGLER × THE DEFINITIVE BUILD × OPEN-AIR DESIGN





ADAPTS TO
ANY CONDITION

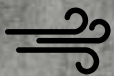

FREEDOM TOP® 3-PIECE
MODULAR HARDTOP

REMOVABLE¹
FULL DOORS

FOLD-DOWN¹
WINDSHIELD

QUICK-CHANGE ARTIST The all-new Wrangler can transition from fully clad and weatherproof to a fully open fresh-air freedom rider in a matter of a few minutes, thanks to purposeful improvements that allow for quick door and window removal, windshield lowering and top opening¹.

THE POWER TO
OPEN UP YOUR WORLD



THE ALL-NEW AVAILABLE **SKY ONE-TOUCH™ POWER TOP** OPERATES WITH THE TOUCH OF A BUTTON, FULLY OPENING THE ROOF IN APPROXIMATELY 20 SECONDS. A UNIQUE SLIDING FUNCTION ALLOWS DEPLOYMENT AT SPEEDS UP TO 55 MPH. FOR EVEN MORE AIR, THE REAR-QUARTER WINDOWS ARE EASILY REMOVABLE¹ WITHIN SECONDS. NO MORE HAVING TO PLAN AHEAD OR PULL OVER FOR SUDDEN RAINSTORMS. THIS IS GOING TO CHANGE THE WAY YOU THINK ABOUT OPEN-AIR FREEDOM FOREVER.

**BIG SKY
ACCESS IS
EASIER THAN EVER**

REDESIGNED FROM THE TOP DOWN, THE MANY IMPROVEMENTS HELP MAKE YOUR SOFT TOP EASIER THAN EVER TO FULLY OR PARTIALLY OPEN, WITH ZIPPERLESS REMOVABLE¹ WINDOWS AND SPRING-ASSISTED, ONE-HANDED OPERATION.

WRANGLER x THE DEFINITIVE GUIDE TO OPEN-AIR DESIGN



Rubicon® in Firecracker Red



GET A REALLY NICE TAN The new Sunrider[®] Soft Top is now available in an attractive Tan, giving you a second choice of top color in addition to Black.



Rubicon Unlimited in Firecracker Red

TAKE-OUT WINDOWS Place your order for a completely open top-down experience. Removing¹ the side and rear windows creates a full-length covering of sunshine that's perfect for feasting on fresh air.

FLIP BACK AND RELAX Better fabric management and easier-to-use retraction handle lets you bring in fresh air faster than ever with minimal effort.



LIGHTWEIGHT AND BREATHABLE

EASIER-TO-REMOVE¹ DOORS
All-aluminum construction makes these doors strong, yet very lightweight, and a built-in handle makes taking them off a breeze. Different-length hinge pins make putting them back on easier than ever too.

OFFICIAL STAMP OF REMOVAL New, exposed aluminum-forged door hinges are standard, all marked with the T-50 designation for the proper-sized TORX® bit needed for easy door removal!





STOP THINKING,
START DOING

CONNECTS YOU TO YOUR WORLD

STAY IN TOUCH AND INFORMED WHEREVER YOU GO. UCONNECT® OFFERS A WIDE RANGE OF COMMUNICATION AND ENTERTAINMENT SERVICES, DELIVERING THEM STRAIGHT INTO YOUR WRANGLER. DISCOVER THIS ROBUST SYSTEM AND HOW YOU'D LIKE TO CONNECT AT DRIVEUCONNECT.COM

WRANGLER x THE DEFINITIVE GUIDE / TECHNOLOGY



TUNE IN TO ALL OF YOUR FAVORITES

Choose from 150 SiriusXM® Satellite Radio® channels, and save favorite artists and songs, using the free app on your smartphone. All included in your one-year trial subscription. Available.



TEXT WITHOUT USING YOUR HANDS

Send and receive calls and text while driving safely with hands-free® phone capability. Uconnect® works with Apple CarPlay™ or Android Auto™, letting you take control through the Uconnect touchscreen. Available.



TALK, AND WRANGLER RESPONDS

Use voice commands® with Siri® Eyes Free® and your connected iPhone® to create and send texts, make and receive calls, access directions and play music. Available.



FIND THE QUICKEST WAY OUT OF TOWN

With SiriusXM Traffic Plus®, you get details on current traffic speed, accidents, construction updates and road closures. Five-year trial subscription included. Available.



KNOW WHAT YOU'RE UP AGAINST

Weather radar and emergency alerts give you an instant snapshot of conditions with SiriusXM Travel Link®. Current conditions and five-day forecasts help you follow the sun. Five-year trial subscription included. Available.

LINK YOUR SMARTPHONE TO UCONNECT®

androidauto

Bring the best of Google along with you in your Uconnect® system. Easy touchscreen navigation and voice recognition lets you access Google Play Music, get directions with Google Maps™ and ask Google any question on the go, at any time. Available.



Works with
Apple CarPlay

Display your favorite

iPhone® apps right on your Uconnect touchscreen. Access your iTunes® library, call anyone in your contacts list and ask Siri® anything. Get directions, make calls and send messages, connect to Apple Music, all without pausing your journey. Available.

Uconnect®

AN
IMPRESSIVE
DISPLAY

A NEW GENERATION OF UCONNECT® TECHNOLOGY TAKES A LEAP FORWARD WITH UP TO AN 8.4-INCH HIGH-DEFINITION TOUCHSCREEN OFFERING A WHOLE UNIVERSE OF MUST-HAVE FEATURES AND CONVENIENT SERVICES. NEVER ROAM ALONE AGAIN.



NAVIGATION



SIRIUSXM TRAVEL LINK®



APPLE CARPLAY™



WEATHER NOTIFICATIONS



ANDROID AUTO™

TOUCHSCREEN CONTROLS Set temperature controls, activate heated seats and steering wheel, plus so much more – all from the touchscreen. A drag-and-drop menu bar allows you to highlight your top six favorite features and services so they're always in sight on your 8.4-inch Uconnect® touchscreen display. Available.

NAVIGATION Dinner reservations at the new place in town? Uconnect employs GPS navigation for audible turn-by-turn directions, and detailed 3-D maps help ensure you arrive on time. The NAV is integrated into your 7-inch Driver Information Display so you can see turn-by-turn directions front and center. With Voice Command®, say the complete address to get directions. Available.

PHONE/TEXT Pair up to ten Bluetooth®-enabled phones. Make hands-free® calls or use your voice to send a text. The Do Not Disturb feature silences incoming calls or texts and sends an auto-reply.

INTEGRATED VOICE COMMAND® Use your voice to select music, make calls, select available navigation destinations, set cabin temps or show fuel prices.

ENTERTAINMENT Listen to your favorite playlist from a connected device, or flip to SiriusXM® Satellite Radio® and enjoy over 150 channels of commercial-free music, plus entertainment, news, comedy and every major sport. Available.

4G WI-FI® HOTSPOT Uconnect® with available Wi-Fi® links compatible devices to the Web so passengers can stay in play along the way. Available

SMARTPHONE INTEGRATION Take mobile connectivity to the next level and seamlessly link your iPhone® or your Android™ phone to your compatible Uconnect system. Apple CarPlay™ lets you stay in touch using your iPhone functions and apps via your Uconnect touchscreen. Android Auto™ is designed to minimize distractions by connecting your Android phone to a simplified interface that's cast onto the Uconnect system's touchscreen. Available.

EMERGENCY HELP In the event of an incident, push the SOS Call¹¹ button. You'll be connected to a SiriusXM Guardian™² agent who contacts 9-1-1, provides your location and stays on the line with you until help arrives. The Roadside Assistance Call¹³ button puts you in touch with an agent who can get you help while you're out on the road. Both safety features are available with SiriusXM Guardian.² Available.

MAKE EVERY START REMOTE

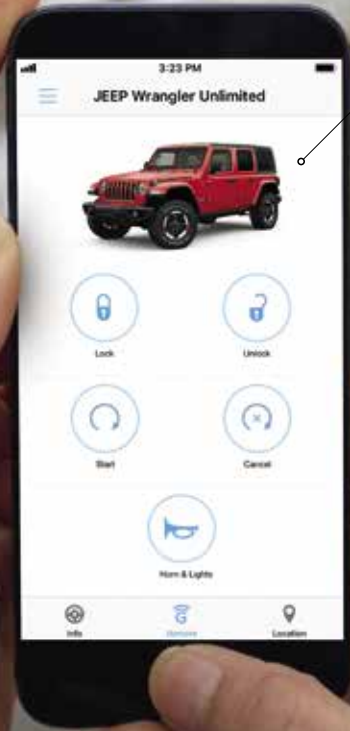

UCONNECT® APP
 SiriusXM Guardian¹² services let you stay connected to your Wrangler from virtually anywhere you go in the world. Add this handy app to your smartphone, and make sure your vehicle is locked from inside the office, or start¹⁴ and pre-warm it while you're finishing dessert after a nice dinner out. And never lose your car in a parking lot again with Vehicle Finder.¹⁵ Do all that and so much more.

SIRIUSXM® SATELLITE SERVICES⁵

WITH YOU WHEREVER YOU GO. TRIPS ARE ENHANCED WITH INFORMATIVE AND ENTERTAINING APPS. ACCESS THEM ON YOUR UCONNECT® TOUCHSCREEN AS WELL AS YOUR SMARTPHONE. CONNECTED TECHNOLOGY KEEPS YOU LINKED TO A WHOLE NEW WORLD.



Uconnect + SIRIUSXM™¹² GUARDIAN

SIRIUSXM GUARDIAN™¹² Drive worry-free with SiriusXM Guardian¹² – a premium suite of safety and convenience services that can be accessed in-vehicle or through the Uconnect® App. Includes a 1-year trial.

- > SOS Call¹¹
- > Roadside Assistance Call¹³
- > In-Vehicle Assistance

UCONNECT® APP FEATURES

- > Lock or unlock your car from virtually anywhere
- > Remotely¹⁴ start your car with the push of a button
- > Flash the lights and sound the horn to help find your car
- > Locate your car on a map using Vehicle Finder¹⁵
- > Send destinations to your navigation system using Send & Go™¹⁶
- > Receive alerts with Theft Alarm Notification¹⁷
- > Stolen Vehicle Assistance¹⁸

SIRIUSXM⁵

SIRIUSXM® SATELLITE RADIO⁵ With the SiriusXM® All Access⁵ package, you get every channel available on your satellite radio, including commercial-free music, plus sports, news, talk and entertainment. You can also listen wherever you go on your portable devices with the SiriusXM App⁵ which is included with your one-year trial. Available.



SIRIUSXM TRAVEL LINK⁵

SIRIUSXM TRAVEL LINK⁵ Access useful information when you need it, right at your fingertips. Get detailed weather maps, five-day forecasts and severe weather alerts, as well as sports scores and in-game weekly schedules on your favorite teams, information on fuel prices in your area and more. Your first five years of SiriusXM Travel Link⁵ are included. Available.



SIRIUSXM TRAFFIC PLUS⁵

SIRIUSXM TRAFFIC PLUS⁵ Avoid congestion before you reach it. Get continuous updates on traffic speed, accidents, construction, road closures and more, before you begin your travels. You will get to your destination faster and more easily than ever before. Your first five years of SiriusXM Traffic Plus⁵ service are included. Available.





AN
INTERFACE
WITH
CLEAR
VISION



**CONFIGURABLE 7-INCH
MULTI-VIEW DRIVER
INFORMATION DISPLAY (DID)**
Controls on the steering wheel
can instantly scroll you through a
selection of vehicle data displayed
in full color within your instrument-
panel gauge cluster. Standard on
Sahara® and Rubicon®

STEERING-
WHEEL
CONTROLS



SEE THE
WORLD
IN A
NEW LIGHT



LED LIGHTING GROUP Maintain a unique presence after dark, while illuminating more of the road ahead. The round headlamps have always been a signature look for Wrangler, and with the new, available LED Lighting Group they'll stand out even more. The available package includes LED headlamps, taillamps, front LED fog lamps and daytime running lamps (DRLs).

RUBICON®

TOUGHER AND BOLDER, THE ALL-NEW RUBICON® REMAINS THE
RECOGNIZED AUTHORITY OF OFF-ROAD CAPABILITY. IT TAKES
FULL COMMAND OF ALL TRAILS, ALWAYS FACING FREEDOM
FULL-ON. GO FARTHER THAN YOU EVER THOUGHT POSSIBLE –
THAT'S THE MANTRA OF THE MOST CAPABLE WRANGLER EVER.





PURPOSEFUL PRESENCE



WRANGLER x THE DEFINITIVE GUIDE / RUBICON

THIS MIGHTY TRAIL MASTER
IS EQUIPPED TO SUPPORT YOUR
ON- AND OFF-ROAD TRAVELS IN
EVERY WAY. AS THE MOST CAPABLE
WRANGLER EVER, THE ALL-NEW RUBICON®
ARRIVES READY TO CLIMB AND OVERCOME
THE MOST GRUELING AND CHALLENGING ROAD
CONDITIONS OUT THERE.



CAPABILITY Purpose-built for virtually any terrain, the all-new Wrangler Rubicon® arrives fully equipped with Rock-Trac® 4WD offering an 84:1 low-gear ratio that masters challenging obstacles with a controlled and steady crawl. Solid and strong Dana® 44 heavy-duty front and rear axles come with standard Tru-Lok® locking front and rear differentials. A standard electronic front sway bar disconnect allows greater front-wheel articulation. A high-performance suspension system keeps the standard 33-inch All-Terrain tires grabbing the ground. Fresh air to help Rubicon keep cool arrives via vents in the standard power dome hood and side vents near both front fenders. And always standard: off-road rock rails to help protect rocker panels from punishing trails, Red tow hooks, and skid plates protecting the underbelly.

POWERTRAIN New options are welcome additions to the Wrangler family, including the powerful and efficient 2.0L Turbo I-4 engine with 270 horsepower and 295 lb-ft of torque. It's always matched to the new maintenance-free 8-speed automatic transmission. The proven 3.6L Pentastar® engine, now with the additional efficiencies of Engine Stop / Start (ESS) technology, can be paired with the new available 8-speed automatic or the standard 6-speed manual.



RUBICON®

UTILITY A new factory-installed auxiliary switchbank is available, making it easy to add up to four accessories and control them from your dashboard. Inside, added utility is available with a seatback storage system that allows various bags to attach to the back of the driver and front-passenger seats. The available Trail Rail™ Cargo Management System adds repositionable anchors to the cargo floor and interior of the swing gate.

COMFORT Whether temps rise or fall, Rubicon keeps you comfortable. Three settings on the available heated front seats warm front passengers while the driver can grip a heated steering wheel. Dual-Zone Automatic Temperature Control adjusts to preset temps to keep the driver and front passenger just right, independently.

TECHNOLOGY The Uconnect® 4C NAV with an 8.4-inch full-color touchscreen gives you 3-D navigation, and Voice Command® with Bluetooth® with standard Apple CarPlay™ and Android Auto™. The available 552-watt Alpine® 9-speaker Premium Audio System, including an overhead sound bar and waterproof subwoofer, inspires every trip with a concert-like audio experience.



Properly secure all cargo.

A COMMANDING VANTAGE

WRANGLER x THE DEFINITIVE GUIDE / RUBICON®

Rubicon® in Firecracker Red and Black leather-trimmed interior with Radical anodized mid-dash and Rubicon Red accent stitching

WRANGLER x THE DEFINITIVE GUIDE / SAHARA®



A DIAMOND
IN THE ROUGH

SAHARA®

FROM ITS METICULOUSLY DESIGNED CABIN TO ITS AUTHENTIC JEEP® BRAND CAPABILITY, THE ALL-NEW SAHARA® IS LADEN WITH EXCEPTIONAL FEATURES FOR THE MOST DISCERNING AND DEMANDING TRAVELER. THIS URBAN WARRIOR MEANS BUSINESS.

Sahara Unlimited in Billet Silver Metallic

SAHARA

PREMIUM LIVING The all-new Wrangler Sahara® kicks it up a notch or two with an available ultra-premium leather-trimmed interior. Detail stitching stands out, along with its embroidered name of fame that has always stood for exceptional style.



GO EVERYWHERE
IN EXCEPTIONAL STYLE

LEATHER-TRIMMED AND ALL-INVITING

Sahara® is crafted for those who appreciate premium refinements designed to enhance Wrangler's natural capability. Leather-trimmed seats and soft-touch surfaces with detailed accent stitching are augmented by elegant brushed painted "Grillz" bezels, handles and knobs. A leather-wrapped front grab handle and ultra-leather-wrapped shift boots with accent stitching add distinctive luxurious touches. Available.

DUAL-ZONE AUTOMATIC TEMPERATURE CONTROL

Set the desired cabin temperature on the Uconnect® touchscreen for both the driver and front passenger and let this climate control system do the rest. It constantly adjusts to maintain constant temperatures. The addition of rear floor heat and air conditioning ducts are comforting to your second-row passengers. Standard.

KEYLESS ENTER 'N GO™

No more fumbling for keys. Keep the key fob in your pocket and you can simply open the door, get comfortably seated with your foot on the brake, press the Start button and head out. Available.

AUXILIARY SWITCH BANK

Option this bank of four switches, conveniently installed in the dashboard at the factory. They're pre-wired to accept accessories, like off-road lights, making their addition clean and hassle-free.

MORE POWER TO YOU

Connect to and power up your devices with the USB, micro USB, 12-volt and audio Jack situated on the front dashboard. An additional 115-volt outlet and two USB ports are on the rear of the center console, especially handy for device users in the second row.

UCONNECT® 4C NAV WITH

8.4-INCH DISPLAY Its large full-color, high-definition touchscreen display provides crystal-clear resolution. You have complete smartphone integration, with Android Auto™ compatibility, Apple CarPlay™ integration, SiriusXM Guardian™ with 4G Wi-Fi® Hotspot, Siri® Eyes Free® voice commands, premium pinch-to-zoom navigation, and more. Available.



EXECUTIVE-LEVEL PROFILE

SAHARA STANDS OUT Unique body trim gives Sahara® a decidedly upscale appearance. An 18-inch aluminum wheel adds unique appeal along with Satin Silver accents on the front bumper and grille. Tubular side steps are functional as well as exceptional, and a Black fuel-filler bezel adds finesse.



FRESH
DISCOVERIES
DEFY
BOUNDARIES



SAHARA® BRINGS A NEW LEVEL
OF STYLE TO THE WRANGLER
EXPERIENCE WITH FINE SEWN
DETAILS, ADVANCED TECHNOLOGIES
AND THE CONVENIENCE OF AVAILABLE
FULL-TIME 4WD. LEAVING CIVILIZATION
BEHIND HAS NEVER BEEN MORE CIVILIZED.

STYLE The unique appearance of Sahara® is crafted with premium Satin Silver accents surrounding the exterior grille slots, headlamps and bumper inserts. Body-color fender flares, along with an available body-color Freedom Top® hardtop or Sky One-Touch™ Power Top, send an upscale message. Add the optional LED Lighting Group for a distinctive modern look with unique LED daytime running lamps (DRLs), headlamps, fog lamps, taillamps and turn signals. Inside, the Platinum Silver theme continues with accents on bezels, knobs and doors. The front grab handle is wrapped in available leather trim, as is the Jeep® Brand steering wheel.

ABILITY Sahara is ready to trek through the toughest road and weather conditions, with the standard 3.6L Pentastar® engine that's paired with the Command-Trac® or Selec-Trac® 4WD systems. You can opt for the new and powerful 2.0L I-4 turbo engine and pair it with the available full-time 4WD system, Selec-Trac®, and enjoy set-it-and-forget-it 4x4 performance always ready for any terrain.

COMFORT The stunning available leather-trimmed interior with contrasting accent stitching is available in Black or Heritage Tan and



SAHARA®

can be outfitted with available heated front seats. Take hold of the available heated steering wheel when temperatures dive. Finding adventure is as easy as opening the door, taking a seat, pushing a button and shifting into Drive with the standard Keyless Go. Maintain a consistent climate for both driver and front passenger with the standard Dual-Zone Automatic Temperature Control.

TECHNOLOGY Sahara keeps you informed, connected and entertained. A standard 7-inch Driver Information Display in the gauge cluster presents a wealth of vehicle data and customization, via steering-wheel controls. Enjoy available in-vehicle 4G Wi-Fi® by choosing the Uconnect® 4C NAV with 8.4-inch full-color touchscreen that includes turn-by-turn navigation. The immersive 9-speaker Premium Sound Group has an overhead sound bar and a weatherproof subwoofer. Active safety systems keep monitoring your vehicle and those around you, with available Blind Spot Monitoring,® Rear Cross-Path Detection® and ParkSense® Rear Park Assist.†

UTILITY Organize all your gear and devices with cargo and storage options, including neat cubbies, multifunctional cup holders and door nets. Secure valuable items in the large center console and oversized glove box, and in-floor storage compartment. The available Trail Rail™ Cargo Management System adds repositionable anchors to the cargo floor and interior of the swing gate.



WRANGLER × THE DEFINITIVE GUIDE / SAHARA®



ALWAYS IN
ITS ELEMENT

Sahara® Unlimited in Bright White

GLOVES ARE
OPTIONAL

THE POWER OF TOUCH

Control the available heated seats and steering wheel either from dash-mounted buttons or the Uconnect® touchscreen, even with gloved hands.



HEATED STEERING WHEEL
Set this optional feature to automatically warm the full 360° circumference of the wheel when temps dip below 40° F.

IN THE ZONE

With available Dual-Zone Automatic Temperature Control, Wrangler can maintain one temperature for the driver and another for the front passenger.



COLD WEATHER GROUP

HEATED FRONT SEATS

You'll have three adjustments to choose from for each seat, so you can tailor your level of warmth to weather conditions and personal preference.

REMOTE START SYSTEM⁴⁴

Start your Wrangler from up to 300 ft away via your key fob or your Uconnect[®] app. You can also activate climate controls, air conditioning, and the heated steering wheel and front seats.

HEATED STEERING WHEEL

Taking hold of a warm steering wheel on a chilly day is the definition of pure comfort.

HEATED MIRRORS Keep ice from building up and blocking your view with the safety of heated side mirrors.

SLUSH MATS

Heavy-duty Mopar[®] Slush Mats are very durable and work hard to protect your carpet from mud and snow.

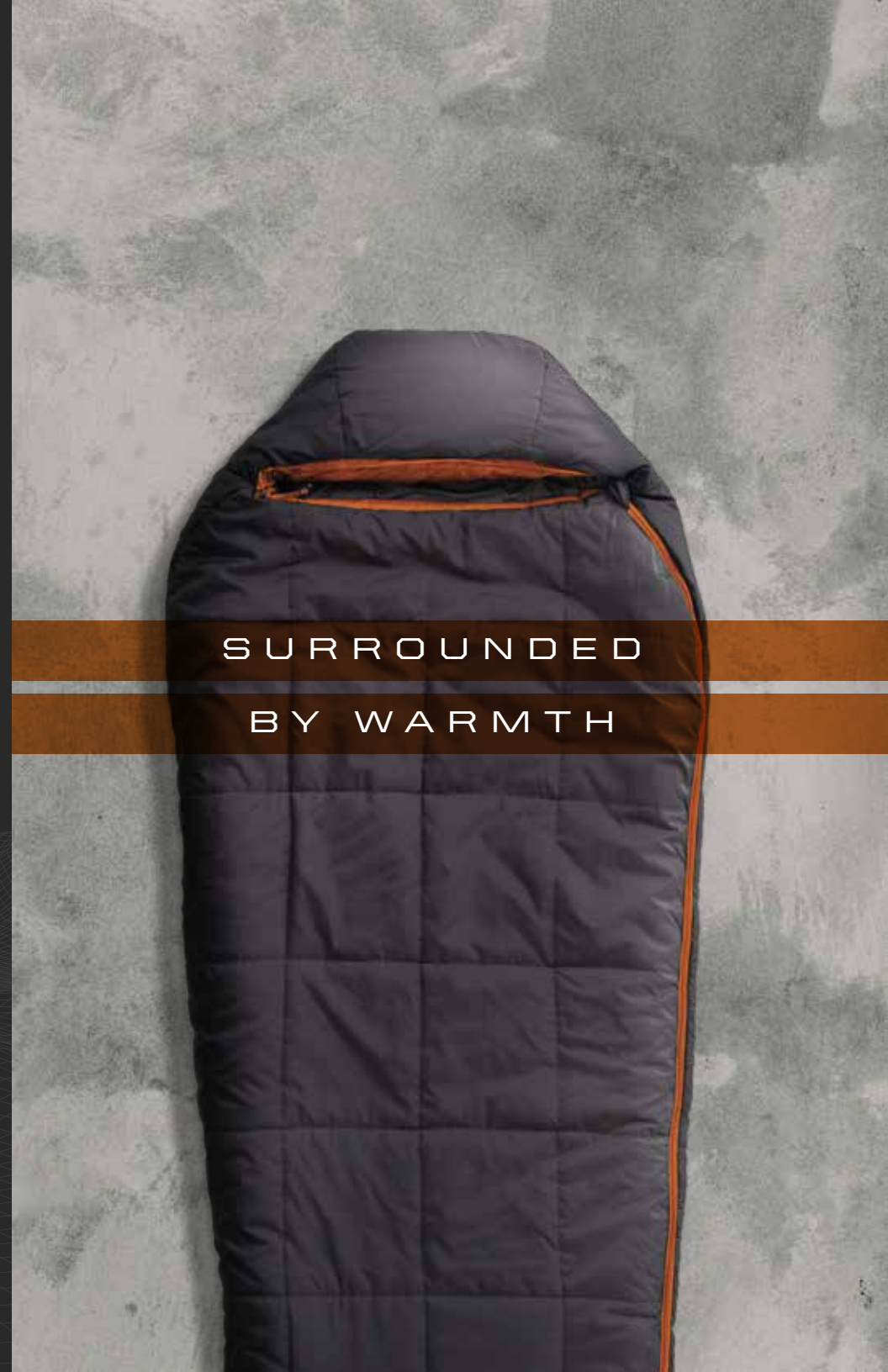

SURROUNDED
BY WARMTH

SPORT

EXPERIENCE EVERYTHING TRULY AMAZING ABOUT THIS NEXT-GENERATION JEEP® WRANGLER. THE ALL-NEW SPORT IS WHERE YOUR WRANGLER JOURNEY BEGINS, UNITING FANS WORLDWIDE. IT'S IMPRESSIVELY OUTFITTED WITH NEW STANDARD FEATURES THAT ADD COMFORT TO WORLD-CLASS CAPABILITY.

WRANGLER × THE DEFINITIVE GUIDE / SPORT





Rubicon® in Bright White and mud brown

WATER-RESISTANT DURABILITY



HOLDS UP AGAINST THE ELEMENTS

IF YOU'RE EVER CAUGHT WITH YOUR TOP DOWN, BE IT UNEXPECTED RAIN, A MUDDY EXCURSION, OR A HEALTHY DOSE OF SLUSH AND SNOW, WRANGLER HAS YOU COVERED, SEALED AND CLEAN.



WEATHERPROOF PUSH-BUTTON START You can't always prepare for sudden rainstorms when you're enjoying your open-air top-down experience. The standard push-to-start button is protected by a water-resistant shield, so you're always able to start up and head out should the weather outside accidentally come inside.



WEATHERPROOF SUBWOOFER Virtually nothing weather-related can cause your exposed subwoofer to give up the ghost. So when you open up to receive everything Mother Nature has to offer, you'll never miss a beat. Available.



WASH-OUT INTERIOR WITH DRAIN PLUGS Fear no mud, dirt or slush. Every Wrangler interior is fully washable and drainable. Simply remove your carpet, get the hose and go to town. Your carpet is weather-resistant, too, and now easier to take out and replace, thanks to new grommets strategically placed to help reattach the carpet in the correct position.



SLUSH MATS AND CARGO LINERS You can't sidestep dirt, but you can avoid excess wear and tear to your interior. Upgrade to super-duty Mopar slush mats and cargo liners. They're made to take a beating and come out clean in the wash. And they show your pride in your ride by proudly displaying the Jeep Brand logo.



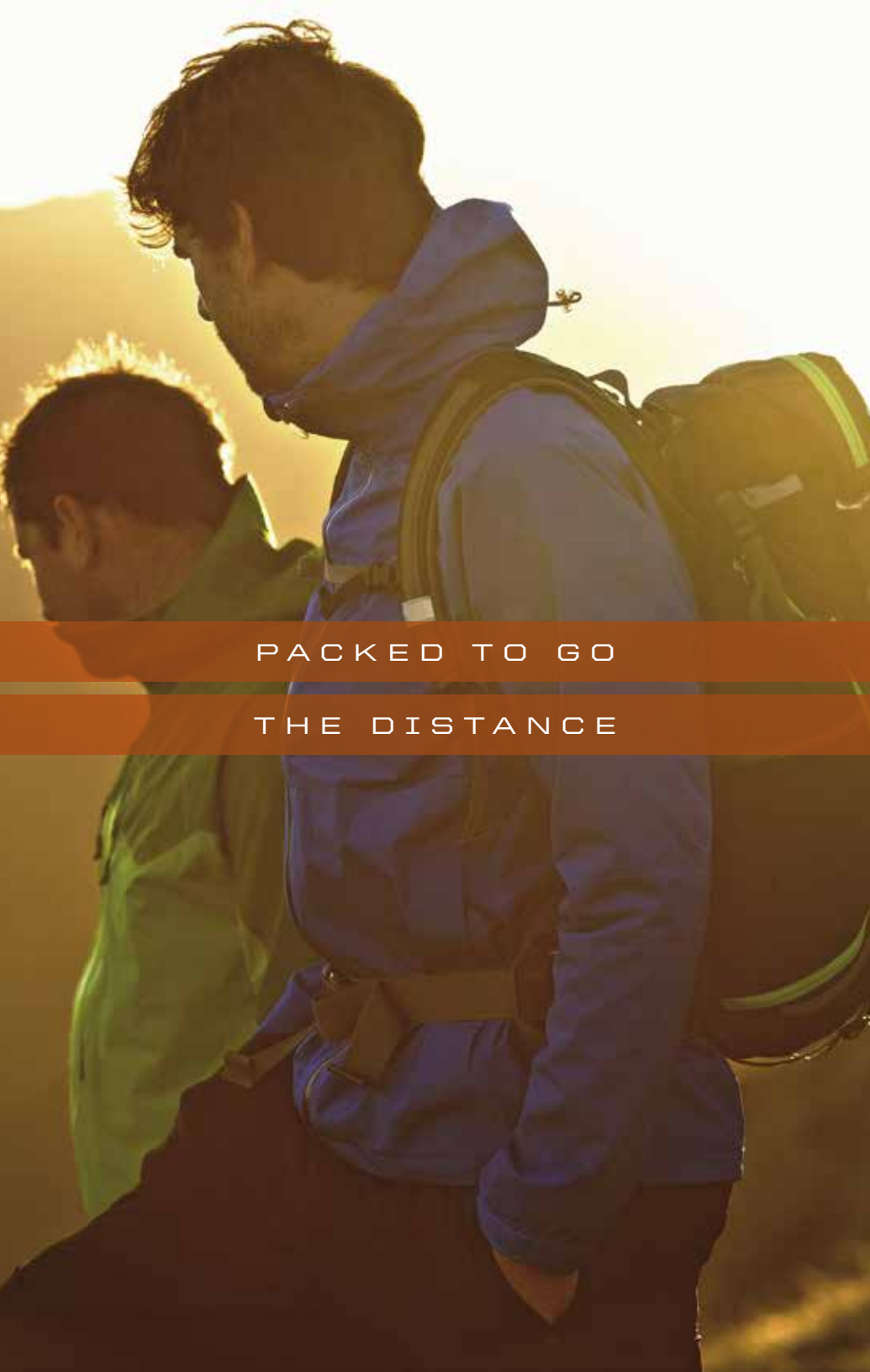

PACKED TO GO
THE DISTANCE



MODULAR SEATBACK JEEP, UTILITY GRID SYSTEM
Exclusive to and integrated into the Rubicon® front seatbacks, it allows for additional flexible storage options. Durable nylon woven straps accommodate standard Modular Lightweight Load-carrying Equipment (MOLLE) style bags. An available Mopar® kit includes a set of three bags (small, medium and large), each with attachment straps and featuring the Jeep® Brand logo.

BINS AND POCKETS The all-new cabin is designed to help you stay organized with cubbies, pockets and bins throughout, giving you plenty of places to store phones, computers, tablets, maps, gaming devices and more.

TRAIL RAIL™ CARGO MANAGEMENT SYSTEM

This modular system incorporates rails in the cargo floor and tailgate, into which locking anchors can be slid or to which a variety of bags and accessories can be mounted. More details on page 82.

CARGO SPACE The all-new Wrangler opens up to give you more cargo room, so you can carry more gear for those really big trips. The 4-door Wrangler offers 72.4 cu ft of fun with the rear seats folded.

Properly secure all cargo.

Properly secure all cargo.

IN-FLOOR STORAGE BIN The cargo floor behind the second row of seats hides a storage area whose lid secures when the swing gate is closed – perfect for storing larger items, like computers and tools.

HANDY HARDWARE The storage bin lid also reveals an area to securely keep bolts from door/top removal¹ and windshield folding!



CENTER CONSOLE STORAGE

Keep valuables secure and hidden from view. Illuminated and big enough to fit an iPad®, the two-tiered center console helps keep items organized with a large main bin and convenient top tray. Cup holders are sized to hold larger beverage containers and have a removable¹ liner for easy cleaning. Plus, there's a dedicated slot for cell phone or key fob storage.

TRAY

GEARBOX

KEY FOB/PHONE SLOT

REMOVABLE¹ LINER



WRANGLER × THE DEFINITIVE GUIDE / UTILITY

EVERYTHING
HAS A PLACE

TRAIL RAIL™ CARGO MANAGEMENT SYSTEM

Accessorize your cargo-carrying capability with this versatile system, optional on all Wrangler models. It includes aluminum rails on the tailgate and cargo floor, along with cargo anchors that lock into place (four anchors included with 2-door models, six with 4-door models). Then choose to add further utility with the available Tailgate Table from Mopar.





EXPLORE
WITH CONFIDENCE

PREPARED FOR THE UNEXPECTED

WITH AN ABUNDANCE OF STANDARD AND AVAILABLE SAFETY AND SECURITY FEATURES, WRANGLER HELPS PREPARE YOU FOR VIRTUALLY ANY ADVERSARIAL CONDITION. ITS BODY MADE OF HIGH-STRENGTH STEEL IS THE ARMOR OF A CHAMPION, OUTFITTED TO ASSIST WITH THE WELL-BEING OF EVERY OCCUPANT.

75+
STANDARD AND AVAILABLE
SAFETY & SECURITY FEATURES



WRANGLER x THE DEFINITIVE GUIDE / SAFETY & SECURITY

BODY STRENGTH Improvements to the safety cage make the muscles of the all-new Wrangler exceptionally solid. Enhanced high-strength steel paired with lightweight aluminum optimizes strength and aids efficiency. Standard.

ULTRASONIC AND ANTI-TILT SECURITY SYSTEM Virtually any movement activates the alarm, like unauthorized wheel removal or towing, the illegal opening of a door, hood or swing gate, ignition start, cutting of battery leads, or when motion inside the cabin is detected. Standard.

ADVANCED MULTISTAGE FRONT AIR BAGS²⁰ When a crash is detected, these air bags²⁰ deploy nearly instantaneously, providing occupant protection that's matched to crash severity. Active vents exhaust air bags²⁰ at appropriate rates, depending on impact. Standard.

UCONNECT[®] MOBILE APP Add this app to your mobile device and use your smartphone to locate your vehicle anywhere in the world. It also allows you to start²¹ Wrangler from anywhere, lock and unlock doors, turn on headlamps, and send navigation directions.

SUPPLEMENTAL FRONT-SEAT-MOUNTED SIDE AIR BAGS²⁰ Deploying from the outboard side of each front seat, these air bags²⁰ enhance the protection of the driver and front-seat passenger in certain impacts. Standard.

UCONNECT VOICE COMMAND⁶ WITH BLUETOOTH[®] Multitasking is the way of today's busy world, even when you're on the road. Uconnect[®] Voice Command⁶ with Bluetooth[®] allows drivers to take or make phone calls, while safely keeping both hands on the wheel. Standard.

SENTRY KEY[®] ENGINE IMMOBILIZER A unique, embedded key code matched only to your vehicle helps keep your Wrangler safely where it belongs. The vehicle will not start if it does not detect the correct key. Standard.

ELECTRONIC STABILITY CONTROL (ESC)¹⁴ A vehicle-wide network of safety sensors provide instant aid should they detect you're veering off your intended path. ESC¹⁴ coordinates systems and sensors, sending them into action when needed. Standard.

ENHANCED ACCIDENT RESPONSE SYSTEM (EARS) This system makes it easier for emergency personnel to see and reach occupants in the event of an accident, turning on interior lighting, flashing hazard lamps and unlocking power doors after air bag²⁰ deployment. Standard.

TRAILER SWAY CONTROL (TSC)¹⁴ Crosswinds and traffic hold no sway over you and your valuable payload. As part of ESC¹⁴, TSC¹⁴ helps keep you and the toys you tow safely on course. Standard.

LED HEADLAMPS, TAILLAMPS AND FOG LAMPS Nighttime driving can bring hidden hazards. With these long-lasting, bright lamps, the road ahead is safely illuminated. Available.

HILL START ASSIST (HSA)²¹ AND HILL DESCENT CONTROL (HDC) HSA²¹ works to prevent Wrangler from rolling when starting on an uphill gradient. HDC is packaged with the 8-speed automatic transmission, helping Wrangler navigate steep declines at a steady speed. Standard.



CHECK SURROUNDINGS
BEFORE BACKING UP



PARKVIEW® REAR BACK-UP CAMERA² WITH TRAILER VIEW When the vehicle is in Reverse, the Uconnect® screen displays a wide-angle view of what's immediately behind your vehicle. This system helps bring previously hidden rear objects to your attention (on-screen or with an audible warning) in good time to react. On-screen dynamic grid lines conveniently help you visualize your path or line up a trailer to your hitch. You can also keep an eye on anything in tow while in motion. The system's camera is cleverly located in the center of the spare tire carrier and has a protective cover that is easily unlocked and removed³ with an included tool. Standard.



NEW ACTIVE SAFETY SYSTEMS ARE CONSTANTLY WORKING TO MONITOR YOUR VEHICLE'S PERIMETER. REST ASSURED, JEEP® WRANGLER REMAINS ON CALL, READY TO NOTIFY YOU WHEN A POTENTIALLY DANGEROUS SITUATION ARISES.



BLIND SPOT MONITORING¹⁹ This system monitors the space between your Wrangler and other vehicles. When a side or rear blind spot is encroached, you're notified via helpful icons illuminated on sideview mirrors, or an audible chime. Available.



REAR CROSS-PATH DETECTION² Activated when your Wrangler is in Reverse, the system uses illuminated icons, as well as an audible chime, to notify you when, for example, a vehicle or pedestrian crosses behind. Available.

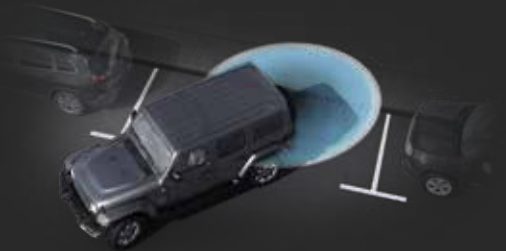

PARKSENSE® REAR PARK ASSIST SYSTEM² Works in tandem with the ParkView® Rear Back-Up Camera² to display previously hidden objects, bringing them to your attention on-screen and with an audible warning so you have time to react. At speeds below 4 mph, the system will automatically bring the vehicle to a stop. Available.

SENSES YOUR
SURROUNDINGS

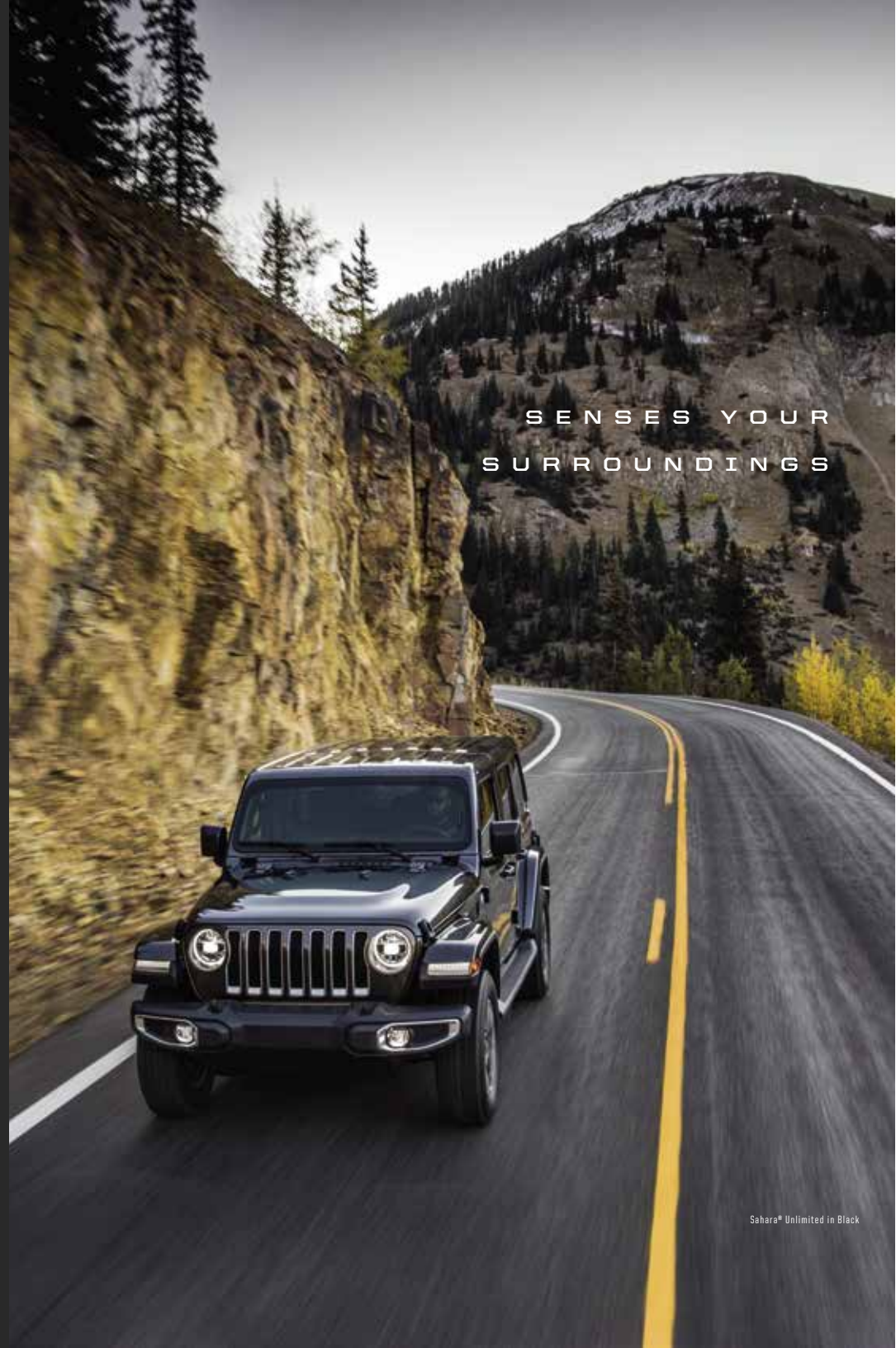

A VERY INCLUSIVE CLUB

DELVE DEEPER INTO THE JEEP® BRAND, WHICH INCLUDES AN EXPANSIVE ARRAY OF EXPERIENCES THAT CAN CREATE LIFELONG CONNECTIONS. EXPAND YOUR ADVENTURES IN EVERY DIRECTION BY VISITING JEEP.COM/EXPERIENCE



JEEP WAVE Every owner of an all-new Wrangler gets auto-enrolled in this exciting program offering a variety of exclusive benefits – like two free oil changes and tire rotations per year, first-day car rental allowance when getting dealer service, up to \$1,000 of trip-interruption coverage, VIP treatment at select events, discounts up to \$500, and 24/7 phone and live chat support. Visit jeep.com/wave for more details.



SOCIAL ADVENTURES Expand your horizons to include authentic and active Jeep® Brand online communities. Post stories, share photos, watch videos and get the latest news from Jeep Brand gearheads and engineers on Facebook, Instagram, Twitter, Pinterest, YouTube and Google+. Tune in and get out into the virtual world where thrilling adventures are happening every single day.

facebook.com/Jeep

instagram.com/Jeepofficial

twitter.com/Jeep

pinterest.com/Jeep

youtube.com/TheJeepChannel

plus.google.com/+Jeep



JEEP® BADGE OF HONOR Experience an online community that invites off-road fans to sign up, download the app and check in to legendary off-road trails across the U.S. – earmarked by the Jeep® Badge of Honor. Members can discover special trails and maps, earn Trail Points and ranks within the community, share photos and learn more about Jeep Trail Ratings. Connect with fellow Jeep vehicle owners and like-minded friends at jeep.com/badge-of-honor

Jeep Gear

JEEP® GEAR Uncover an extensive line of fun developed exclusively for Jeep® Brand enthusiasts. From authentic wearables to unique gifts, all items are as rugged and durable as your Jeep Brand vehicle. Express your true nature. Learn more at jeep.com/gear





YOUR NEXT ADVENTURE
MAY WELL BE THE BEST



JEEP. JAMBOREES For those with an adventurous spirit, join us on the trail. Head for parts unknown or return to fun, familiar places. Jeep Jamboree U.S.A. offers off-road adventure weekends that bring together the outdoors, down-to-earth people and their Jeep Brand 4WD vehicles. Explore America's backcountry at jeepjamboreeusa.com

IF YOU CAN DREAM IT,
YOU CAN BUILD IT
WITH JEEP PERFORMANCE PARTS



CUSTOMIZE YOUR DREAM MACHINE

WITH JEEP® PERFORMANCE PARTS, IT'S EASY TO MAKE YOUR ALL-NEW WRANGLER EXTRA SPECIAL AND ATTENTION-GRABBING. THESE HARD-CORE PRODUCTS ARE SPECIFICALLY DESIGNED TO ENHANCE YOUR OFF-ROAD EXPERIENCE.



KATZKIN® DELUXE LEATHER SEATING SURFACES

GRAB HANDLES

OVERSIZED SPARE TIRE CARRIER MODIFICATION KIT

BLACK FUEL-FILLER DOOR

SNORKEL KIT

5-INCH OFF-ROAD LED LIGHT KIT

RUBICON® HOOD PACKAGE

7-INCH OFF-ROAD LED LIGHT KIT

SATIN BLACK GRILLE

GRILLE AND WINCH GUARD HOOP

JEEP PERFORMANCE PARTS RUBICON WINCH AND WINCH MOUNTING KIT

RUBICON STEEL STUBBY BUMPER

2-INCH LIFT KIT WITH FOX® SHOCKS

RUBICON FENDER FLARES

LOWER A-PILLAR LIGHT MOUNTING BRACKET

JEEP® PERFORMANCE PARTS ROCK RAILS

17-INCH BEADLOCK WHEELS

TUBE DOORS





WRANGLER SNORKEL 1
 GRILLE AND WINCH GUARD HOOP 2
 WINCH GUARD LIGHT MOUNTING BRACKET 3
 LOWER A-PILLAR LIGHT MOUNTING BRACKET 4
 CENTER HIGH-MOUNTED STOP LIGHT (CHMSL) RELOCATION KIT 5

TAILGATE REINFORCEMENT SYSTEM 6
 BIG BRAKE KIT 7

JEEP® TRAIL RATED® WINCH ACCESSORY KIT 8
 REAR RUBICON® CRATE AXLE 9
 ALL-WEATHER FLOOR MATS 10

STAINLESS STEEL DOOR SILL GUARDS 11
 2-INCH LIFT KIT WITH FOX® SHOCKS 12
 JEEP PERFORMANCE PARTS RUBICON WINCH 13



14 SATIN CHROME FUEL-FILLER DOOR

15 AMERICAN FLAG HOOD GRAPHIC

16 ROOF-TOP CARGO CARRIER*

17 TAILGATE TABLE

18 GRAB HANDLES

19 FRONT-END COVER AND HOOD COVER

20 JEEP® PERFORMANCE PARTS ROCK RAILS

21 CARGO NET*

22 BLACK TUBULAR SIDE STEPS

23 17-INCH CAST ALUMINUM WHEEL, JET BLACK

24 SILVER VALVE STEM COVERS

25 HOOD LATCH

26 JEEP PERFORMANCE PARTS BADGE

27 SUN BONNET

28 17-INCH CAST ALUMINUM WHEEL, GEAR DESIGN



MAKE IT MOPAR®

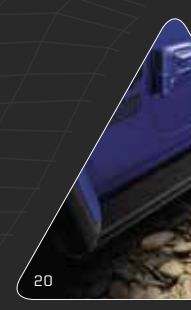

*Properly secure all cargo.

COLORS & TRIM LEVEL OVERVIEW

- 1 Firecracker Red
- 2 Punk'n Metallic
- 3 Granite Crystal Metallic
- 4 Ocean Blue Metallic
- 5 Billet Silver Metallic
- 6 MOJITO!
- 7 Bright White
- 8 Black
- 9 Sting-Gray
- 10 HELLAYELLA*

*Late availability

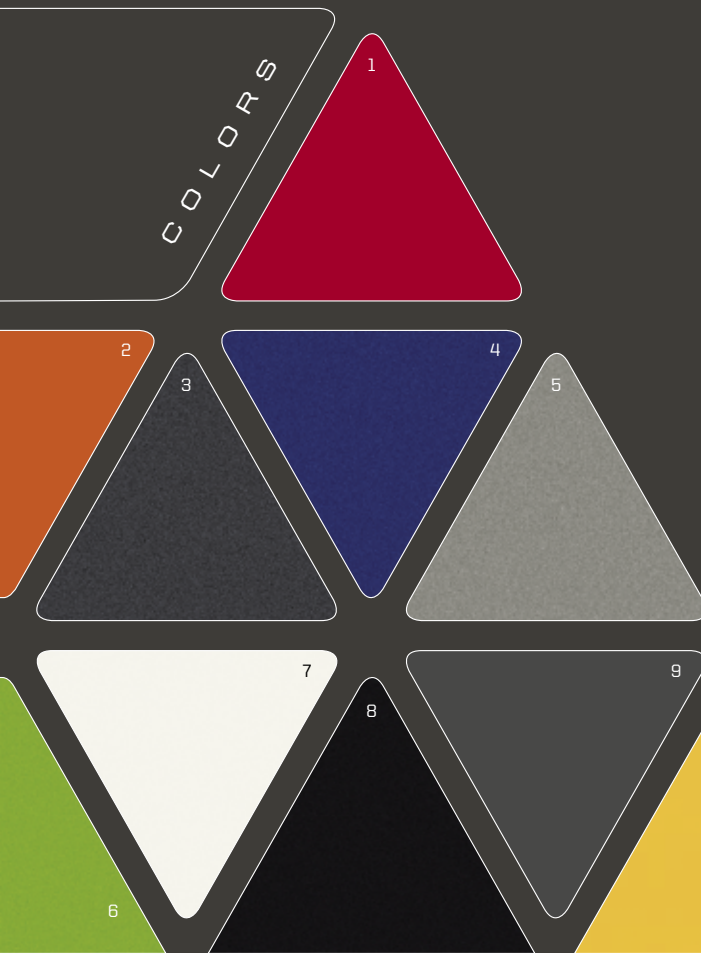

RUBICON®

KING OF THE MOUNTAIN The undisputed off-road master claims the title of the Most Capable Wrangler Ever, and with good reason... Rubicon arrives fully equipped with all of the proven features that make it worthy of tackling the world's wildest terrain. Standard features include: 33-inch All-Terrain tires, locking front and rear Dana® 44 heavy-duty axles, electronic sway bar disconnect, Rock-Trac® 4:1 transfer case with an improved crawl ratio of up to 84:1, steel off-road rock rails and skid plates, and a vented power dome hood.



Rubicon Unlimited in Billet Silver Metallic with optional leather-trimmed seats, body-color fender flares and Steel Bumper Group

SAHARA®

EXCEPTIONALLY CRAFTED Sahara gives you the best of all worlds. Enjoy premium cabin comforts matched with the full-on strength of Wrangler and its authentic Jeep® Brand four-wheel drive. Standard features include: Next-Generation Uconnect® 4 with 7-inch touchscreen, 7-inch reconfigurable Driver Information Display, weatherproof push-button start, Dual-Zone Automatic Temperature Control, soft-wrapped console lid and armrests with accent stitching, 18-inch aluminum wheels, ParkView® Rear Back-Up Camera², body-color fender flares and grille with accents, and side steps.



Sahara® Unlimited in Bright White with optional body-color Freedom Top®

SPORT

THRILLS START HERE With Sport, you'll have everything that's truly amazing about the all-new Wrangler. Standard features include: 3.6L Pentastar® V6 engine, Command-Trac® transfer case, Dana solid front and rear axles, ParkView Rear Back-Up Camera², Uconnect 3 with 5-inch touchscreen, 3.5-inch Driver Information Display, 8-speaker sound system with overhead sound bar, push-button start, supplemental front-seat side air bags²⁰, tow hooks and skid plates, and a washable interior with easy-to-remove¹ carpet and drain plugs.



Sport S Unlimited in Firecracker Red with optional 17-inch aluminum wheels

STANDARD & OPTIONAL FEATURES



SPORT

- 3.6L Pentastar® V6 engine with 6-speed manual transmission and 3.45 axle ratio
- Command-Trac® 4x4 system
- Dana® axles
- Skid plates for fuel tank, transfer case
- Front and rear tow hooks
- Halogen headlamps and fog lamps
- Sunrider® Soft Top in Black vinyl
- Full-framed removable¹⁴ doors
- 17-inch Steel Low-Gloss Black wheels
- P245/75R17 Michelin® LTX MS2, BSW, All-Season tires
- Full-size spare tire
- Cloth seating with Silver Platinum dash mid-panel
- Tilt/telescoping steering column
- Push-button start
- Cruise control

- Fold and Tumble removable¹ rear bench seat (2-door only) with fold-down headrests for improved visibility
- AVAILABLE exclusively on Sport**

 - Air conditioning (2-door only, standard on 4-door)
 - SiriusXM® Satellite Radio⁵ with 1-year trial subscription
 - Deep-tint sunscreen windows, rear and quarter

SPORT S

INCLUDES SPORT FEATURES, PLUS:

- 17-inch aluminum Tech Silver Metallic wheels
 - Leather-wrapped steering wheel
 - Air conditioning
 - Power windows/locks with keyless entry
 - Power heated mirrors
 - Automatic headlamps
 - Deep-tint windows, rear and quarter
- AVAILABLE exclusively on Sport S**

 - Side steps
 - 17-inch aluminum painted/polished wheels

- 17-inch aluminum Tech Silver Metallic wheels
- Leather-wrapped steering wheel
- Air conditioning
- Power windows/locks with keyless entry
- Power heated mirrors
- Automatic headlamps
- Deep-tint windows, rear and quarter

- Hill Start Assist (HSA) and Electronic Roll Mitigation (ERM)
- Advanced multistage driver and front-passenger air bags⁵⁰
- Supplemental front seat-mounted side air bags⁵⁰
- Tire Pressure Monitoring Display
- Sentry Key® anti-theft engine immobilizer
- 12-volt outlets
- Cargo anchors with Trail Rail™-ready inserts in floor and tailgate
- Full center console with locking storage
- Auto-dimming rearview mirror
- Torx® tool kit for top/door removal¹
- Wash-out interior with removable¹ carpet with sound barrier and drain plugs

- CONVENIENCE GROUP:** Universal garage door opener²²; Remote Start System¹⁴ (automatic transmission only)
- TECHNOLOGY GROUP:** Uconnect 4 with 7-inch touchscreen, Bluetooth, Apple CarPlay™, Android Auto™, Siri® Eyes Free®, AM/FM radio, audio input jack, USB port and steering wheel-mounted music controls, air conditioning with Automatic Temperature Control, 7-inch full-color Driver Information Display, and air filtration

SAHARA

INCLUDES SPORT S FEATURES, PLUS:

- 18-inch aluminum polished wheels with painted Granite Crystal spokes
- P265/70R18 Bridgestone® Dueler, All-Season tires
- Side steps
- Body-color fender flares
- Unique front and rear bumpers with Silver bezels
- Silver grille inserts
- Cloth seats with Sahara logo
- Grillz dash mid-panel
- 7-inch full-color Driver Information Display
- Uconnect 4 with 7-inch touchscreen
- Dual-zone Automatic Temperature Control
- 115-volt auxiliary power outlet
- Universal garage door opener²²

- AVAILABLE exclusively on Sahara**

 - Selec-Trac® Full-Time 4WD System
 - 18-inch aluminum polished face wheels with painted Tech Gray windows
 - Leather-trimmed seats with embroidered Sahara logo, Light Tungsten accent stitching and Black Monaco dash mid-panel

RUBICON

INCLUDES SPORT S FEATURES, PLUS:

- Rock-Trac® 4x4 system
- Tru-Lok® front/rear locking differentials
- Front sway bar disconnect system
- Dana 44 heavy-duty axles
- Performance suspension system with high-pressure monotube shocks and tunable valves
- High-clearance front fender flares
- Rock rails
- Vented hood with Rubicon decal
- Front and rear tow hooks in Red
- Unique front and rear bumpers with Gray bezels
- Gray grille inserts
- Fuel filler door
- 17-inch aluminum polished wheels with Mid-Gloss Black pockets
- 33-inch BFGoodrich® KO2 off-road tires
- Cloth seats in Black with Rubicon logo, Red accent stitching, and either Radical Anodized or Silver Platinum dash mid-panel
- Modular Seatback Jeep® Utility Grid System™
- 7-inch full-color Driver Information Display
- Uconnect 4 with 7-inch touchscreen
- Dual-zone Automatic Temperature Control
- 115-volt auxiliary power outlet
- Universal garage door opener²²

- AVAILABLE exclusively on Rubicon**

 - 17-inch aluminum Mid-Gloss Black wheels with polished lip
 - Body-color fender flares
 - Leather-trimmed seats with Rubicon Red embroidered Rubicon logo and accent stitching, and Radical Anodized dash mid-panel

STEEL BUMPER GROUP: Winch-capable front steel bumper with integrated fog lamps and removable¹ end caps and steel rear bumper (must have LED Lighting Group)

- AVAILABLE on ALL trim levels (unless noted)**

 - 2.0L Turbo I-4 engine
 - 8-speed automatic transmission
 - Trac-Lok® limited-slip differential (not available on Rubicon)
 - Freedom Top® Black 3-piece modular hardtop with rear wiper/washer, rear defroster and Freedom Panel storage bag
 - Mopar® Hardtop Headliner
 - Premium Black or Heritage Tan Sunrider Soft Top with upgraded fabric and quieter performance (not available on Sport)
 - Alpine® Premium Sound System with 9 speakers including an all-weather subwoofer, 552W 12-channel amplifier, 220-amp alternator (not available on Sport)
 - Trail Rail Cargo Management System (not available on Sport)
 - Mopar All-Weather Floor Mats
 - Engine block heater
 - Jeep Trail Rated® Kit - tow strap, gloves, D-ring and storage bag

DUAL TOP GROUP: Black Freedom Top 3-piece hardtop and premium Black Sunrider Soft Top (Wrangler Unlimited only)

TRAILER TOW AND HD ELECTRICAL GROUP: Class II hitch receiver, 4- and 7-pin wiring harness, 240-amp alternator, 700-amp maintenance-free battery, four pre-wired auxiliary switches

COLD WEATHER GROUP: Heated steering wheel, heated front seats, Remote Start System¹⁴ (automatic transmission only)

JEEP ACTIVE SAFETY GROUP: Blind Spot Monitoring™ and Rear Cross-Path Detection®; ParkSense® Rear Park Assist System; LED taillamps (not available on Sport)

SMOKER'S GROUP: Removable¹ ashtray and lighter

- AVAILABLE on Sahara and Rubicon**

 - Sky One-Touch™ Power Top with single-button operation and removable¹ rear quarter panels
 - Freedom Top body-color 3-piece modular hardtop with rear wiper/washer, rear defroster and Freedom Panel storage bag
 - Keyless Enter™ 'n Go™ proximity entry
 - Remote Start System¹⁴ (automatic transmission only)

LED LIGHTING GROUP: LED daytime running lamps, headlamps, taillamps, and fog lamps

ELECTRONIC INFOTAINMENT GROUP: Uconnect 4C NAV with 8.4-inch touchscreen, GPS navigation, Bluetooth, Apple CarPlay, Android Auto®, Siri Eyes Free®, AM/FM radio, HD radio, SiriusXM Satellite Radio® (1-year trial subscription), SiriusXM Guardian™ (1-year trial subscription), SiriusXM Traffic Plus® (5-year trial subscription), SiriusXM Travel Link® (5-year trial subscription), audio input jack, USB port, Alpine Premium Sound System, auto-dimming rearview mirror



BUILD YOURS: Use this quick guide to review standard features, pick the available options you want, then head over to jeep.com to build and price your new Wrangler. You can even check your local dealer's inventory.

WHEELS & INTERIORS

WHEELS

1) 17-inch Steel Low-Gloss Black 2) 17-inch Aluminum Tech Silver Metallic 3) 17-inch Aluminum Painted/Polished 4) 18-inch Aluminum Polished with Painted Granite Crystal Spokes 5) 18-inch Aluminum Polished Face with Painted Tech Gray Windows 6) 17-inch Aluminum Polished with Mid-Gloss Black Pockets 7) 17-inch Aluminum Mid-Gloss Black with Polished Lip

SPORT

SPORT S

SAHARA*

RUBICON*

STANDARD

1



2



4



6



OPTIONAL

3



5



7



SPORT / SPORT S



SOULMATE CLOTH with Peak embossment in Black with tonal stitching and Silver Platinum painted mid bolster



SOULMATE CLOTH with Peak embossment in Heritage Tan with tonal stitching and Silver Platinum painted mid bolster

SAHARA



SOULMATE CLOTH with Peak embossment in Black with tonal stitching and Grillz painted mid bolster



SOULMATE CLOTH with Peak embossment in Heritage Tan with tonal stitching and Grillz painted mid bolster



MCKINLEY LEATHER-TRIMMED in Black with embroidered Sahara logo, Light Tungsten accent stitching and Monaco wrapped mid bolster



MCKINLEY LEATHER-TRIMMED in Heritage Tan with embroidered Sahara logo, Light Tungsten accent stitching and Monaco wrapped mid bolster

A COMPLETELY REDESIGNED INTERIOR INCLUDES RESPECTFUL NODS TO HERITAGE AND PROVIDES THE LATEST DESIGN AND TECHNOLOGY UPGRADES THAT ENHANCE DRIVER AND PASSENGER COMFORT AND CONVENIENCE. A LONG LIST OF STANDARD FEATURES IS AUGMENTED BY A RICH SELECTION OF COOL STUFF YOU CAN ADD ON TO CREATE THE WRANGLER YOU'VE ALWAYS WANTED.

RUBICON



MADDOX EMBOSSED CLOTH in Black with embroidered Rubicon logo, Rubicon Red accent stitching, and either painted Redical or Silver Platinum mid bolster, depending on exterior paint color



MCKINLEY LEATHER-TRIMMED in Black with embroidered Rubicon logo, Rubicon Red accent stitching, and either painted Redical or Silver Platinum mid bolster, depending on exterior paint color



MCKINLEY LEATHER-TRIMMED in Heritage Tan with embroidered Rubicon logo, Light Tungsten accent stitching, and painted Silver Platinum mid bolster



OWNER BENEFITS & PROGRAMS

5 YEAR / 60,000 MILE POWERTRAIN LIMITED WARRANTY²³

WARRANTIES Jeep® Brand vehicles are covered by a 3-Year/36,000-Mile Basic Limited Warranty²³ (excludes normal maintenance and wear items), as well as a 5-Year/60,000-Mile Powertrain Limited Warranty²³ that is fully transferable. See your dealer for complete details.



**VEHICLE
PROTECTION**

**MOPAR® VEHICLE
PROTECTION** Mopar Vehicle Protection®

(MVP) has a vested interest in your owner experience and is the only extended protection provider backed by the manufacturer, FCA US LLC. We stand behind every MVP plan with certified, factory-trained technicians and the use of authentic Mopar® parts. Your plan is honored at over 2,600 dealerships within the U.S., Canada, Puerto Rico and Mexico. Be sure to ask for a Mopar Vehicle Protection plan at your dealership, call (800) 442-2666 or visit moparvehicleprotection.com



AUTOMOBILITY PROGRAM
The FCA US LLC
Automobility Program

provides aftermarket reimbursement incentives on adaptive vehicle upfit equipment to help provide safe and reliable vehicle modifications, enhancing accessibility for all people. For more information, call (800) 255-9877 or visit fcausautomobility.com



JEEP® DRIVEPLUSSM MASTERCARD®

Apply today for a Jeep® DrivePlusSM Mastercard® and upon approval earn a \$100 statement credit toward your first FCA US in-dealership purchase AND earn 5% back on FCA US dealership purchases, 2% back on gas and travel purchases, and 1% back on purchases everywhere else²⁴ Double Redemptions (2X) when you redeem towards your next FCA US dealership service or your next Jeep vehicle purchase. Visit drivepluscard.com or visit a participating dealer to learn more.

SPECIFICATIONS

EXTERIOR DIMENSIONS

(2-door / 4-door Rubicon® with Soft Top; inches unless noted)

Wheelbase	96.8 / 118.4
Overall Length (with spare tire)	166.8 / 188.4
Overall Width	73.8
Track (front / rear)	62.9
Height	73.6
Ground Clearance (at curb weight)	10.8
Approach Angle (degrees)	44 / 43.9
Breakover Angle (degrees)	27.8 / 22.6
Departure Angle (degrees)	37
Water Forging Depth ³	30

INTERIOR DIMENSIONS

(2-door / 4-door with Soft Top; inches unless noted)

Seating Capacity: 2-door (front / rear)	2 / 2 adults
4-door (front / rear)	2 / 3 adults
Head Room: front	42.6
rear	41.7
Leg Room: front	41.2
rear	35.7 / 38.3
Shoulder Room: front	55.7
rear	57.7 / 55.7
Hip Room: front	53.9
rear	45 / 56.7
Front-seat Volume Index (cu ft)	53.8
Rear-seat Volume Index (cu ft)	49.9
Cargo Lifter Height:	29.7
Cargo Volume (cu ft):	
rear seat up	12.9 / 31.7
rear seat folded	46.9 / 72.4

CAPACITIES / WEIGHTS (2-door / 4-door; pounds unless noted)

Fuel Tank (gallons)	17.5 / 21.5
Base Curb Weight	
2.0L	4,010 / 4,320
3.6L	3,970 / 4,215
Maximum Payload Capacity (with all occupants and cargo)	1,071 / 1,380
Gross Vehicle Weight Rating (GVWR) (when properly equipped)	5,250 / 5,800

TOWING DATA (2-door / 4-door; pounds unless noted)

Towing Capacity:	
2.0L	2,000 / 3,500
3.6L	2,000 / 3,500
Tongue Load Limit	200 / 350
Maximum Trailer Frontal Area (sq ft)	20 / 30



Jeep® Wave Equipped.

JEEP® WAVE The thrill of owning a Jeep® Brand vehicle now extends beyond the road or trail with the Jeep Wave program. Every owner of an all-new Wrangler gets auto-enrolled in this exciting program offering a variety of exclusive benefits – like a dedicated number to call when you have questions, maintenance services and more. Visit jeep.com/wave for more details.

JEEP WAVE BENEFITS:

- > Two free oil changes and tire rotations a year
- > First-day car rental allowance
- > Up to \$1,000 of trip-interruption coverage
- > VIP treatment at events featuring Jeep® Brand vehicles
- > Discounts that help you save up to \$500
- > 24/7 phone and live chat support

